



# Declaration of Conformity



**Type of equipment:** NETWORK CAMERA  
**Brand Name /Trade Mark:** SAMSUNG  
**Type designation /model:** SND-L5083RP  
**Applicant:** Samsung Techwin Co., Ltd.

**In accordance with the following Directives:**

2004/108/EC The Electromagnetic Compatibility Directive  
Including amendments by the CE Marking Directive 93/68/EEC

2011/65/EU Restriction of the use of certain hazardous substances in electrical and electronic equipment (recast)

**The following harmonized European standards or technical specifications have been applied:**

EN 55022:2010 Limits and methods of measurement of radio disturbance characteristics of information technology equipment  
EN 50581:2012 Technical documentation for the assessment of electrical and electronic products with respect to the restriction of hazardous substances  
EN 55024:2010 Information technology equipment-Immunity characteristics-Limits and methods of measurement  
EN 61000-4-2:2009 Electrostatic discharge immunity test  
EN 61000-4-3:2006+A2:2010 Radiated, radio-frequency, electromagnetic field immunity test  
EN 61000-4-4:2012 Electrical fast transient/burst immunity test  
EN 61000-4-6:2009 Immunity to conducted disturbances, induced by radio-frequency fields

**The CE Marking on the products and/or their packaging signifies that SAMSUNG TECHWIN CO., LTD. holds the reference technical file available to the European Union authorities.**

**Place and date of issue:** 84, Jeongdong-ro, Seongsan-gu, Changwon-si, Gyeongsangnam-do, Korea / March 16, 2015

**Authorized Signatory:** Name : Jei Soon, Kang  
Title : Principal Research Engineer

Signature :

## CE Conformance EMC Test Report

**Test Report No.** : KES-E1-15T0077  
**Date of Issue** : 03. 16. 2015  
**Description of Product** : NETWORK CAMERA  
**Model No.** : SND-L5083RP  
**Variant Model** : -  
**Applicant** : Samsung Techwin Co., Ltd.  
**Address** : 84, Jeongdong-ro, Seongsan-gu, Changwon-si, Gyeongsangnam-do, Korea  
**Manufacturer** : TIANJIN SAMSUNG TECHWIN OPTO-ELECTRONIC CO., LTD  
**Address** : No.11 Weiliu Road. Micro-Electronic Industrial Park Jingang Road Tianjin 300385, China  
**Applicable Regulation** : **EMC Directive 2004/108/EC**  
EN 55022:2010  
EN 50130-4:2011

**Date of Receipt** : 02. 26. 2015  
**Test Date** : 03. 02. 2015 ~ 03. 03. 2015

**Tested by:**

  
Kang Hyeon, Kim  
Test Engineer

**Reviewed by:**

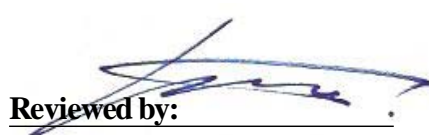
  
Dong Hun, Jang  
Technical Manager



Testing Laboratories for Safety and RF Compliance  
C-3701 40, Simin-daero 365beon-gil, Dongan-gu, Anyang-si, Gyeonggi-do, 431-716, Korea  
Tel: +82-31-425-6200 / Fax: +82-31-424-0450

Testing Laboratories for EMC Compliance  
473-29, Gayeoro, Yeoju-si, Gyeonggi-do, 469-803, Korea  
Tel : +82-31-883-5092 / Fax: +82-31-883-5169



**KES Co., Ltd.**

C-3701, 40, Simin-daero 365beon-gil,  
Dongan-gu, Anyang-si, Gyeonggi-do, 431-716, Korea  
Tel: +82-31-425-6200 / Fax: +82-31-424-0450  
www.kes.co.kr

Test report No.:  
KES-E1-15T0077  
Page (2) of (61)

---

## Revision history

Revision	Date of issue	Test report No.	Description
-	03. 16. 2015	KES-E1-15T0077	Initial

---

This report shall not be reproduced except in full, without the written approval of KES Co., Ltd.  
The test results in the report only apply to the tested sample.

## TABLE OF CONTENTS

<b>1</b>	<b>General Information</b>	4
<b>2</b>	<b>Product Labelling Requirements</b>	11
<b>3</b>	<b>Applicable Regulations</b>	12
<b>4</b>	<b>Test standards and results</b>	15
<b>5</b>	<b>Test Performed</b>	15
5.1	Conducted Emission Measurements	15
5.2	Radiated Emission Measurements	21
5.3	Harmonics / Voltage Fluctuations Measurements	29
5.4	Electrostatic Discharge Immunity	33
5.5	Radio-frequency electromagnetic field Amplitude modulated Immunity	35
5.6	Fast Transients Immunity	38
5.7	Surge Immunity	41
5.8	Radio-frequency continuous conducted Immunity	43
5.9	Voltage Dips and Interruptions Immunity	45
<b>6</b>	<b>Test Setup Photographs</b>	47
6.1	Conducted Emission	47
6.2	Radiated Emission	49
6.3	Harmonics / Voltage Fluctuations Measurements	51
6.4	Electrostatic Discharge Immunity	51
6.5	Radio frequency electromagnetic field immunity	52
6.6	Fast Transients Immunity	52
6.7	Surge Immunity	53
6.8	Radio-frequency continuous conducted Immunity	53
6.9	Voltage Dips and Interruptions Immunity	54
<b>7</b>	<b>External Photographs</b>	55
<b>8</b>	<b>Internal Photographs</b>	57
	Appendix A -Schematics/Block Diagram	60
	Appendix B - User's Manual	61

---

## 1. General Information

### 1.1 Introduction

The EMC Test Report for CE Declaration of Conformity is prepared on behalf of named applicant in accordance with the EMC Directive(2004/108/EC) of the European Economic Community. The test results reported in this document relate only to the item that was tested.

All radiated emission, conducted emission measurements required by the EMC Directive were performed manually at KES Co., Ltd. (here in after called KES), 473-29, Gayeo-ro, Yeosu-si, Gyeonggi-do, 469-803 KOREA.

The radiated emission measurements performed on 10 meter, Open Area Test Site, test range maintained by KES. Complete ANSI63.4;2009 description and site attenuation measurement data records are maintained at the test facility and have been placed on file with the Federal Communications Commission.

All immunity measurements required by the EMC Directive were performed manually at KES Co., Ltd. (here in after called KES), 473-29, Gayeo-ro, Yeosu-si, Gyeonggi-do, 469-803 KOREA.

The immunity measurements were performed in a shielded enclosure and/or anechoic chamber also located at the same facility.

The KES EMC test facilities in Yeosu-si are designated testing laboratory according to ISO/IEC 17025 by Radio Research Agency(RRA), Korea Communication Commission.

## 1.2 Product Description for Equipment Under Test (E.U.T)

Samsung Techwin Co., Ltd., NETWORK CAMERA, Model No: SND-L5083RP or the "E.U.T" as referred to in this report is base model.

Main Specifications of EUT are:

	SND-L5083R
Video	
Imaging Device	1/2.9" 1.37M CMOS
Total Pixels	1,312(H) x 1,069(V)
Effective Pixels	1,305(H) x 1,049(V)
Scanning System	Progressive
Min. Illumination	Color: 0.07Lux(1/30sec, F1.4, 50IRE), 0.001Lux(2sec, 50IRE) Color: 0.02Lux(1/30sec, F1.4, 30IRE)  B/W : 0 Lux (IR LED on)
Lens	
Focal Length (Zoom Ratio)	3~10mm V/F
Max. Aperture Ratio	F1.4
Angular Field of View	H: 82.0°(Wide)~26.5°(Tele)(±5%), V: 59.7°(Wide)~19.9°(Tele) (±5%) D: 96.6° (Wide)~32.4°(Tele)
Min. Object Distance	0.5m
Focus Control	Manual
Lens Type	DC auto iris
Mount Type	Board type
Pan / Tilt / Rotate	
Pan Range	0~354°
Tilt Range	0~67°
Rotate Range	0~355°
Operational	
IR Viewable Length	10m
Camera Title	Off / On (Displayed up to 15 characters)
Day & Night	True Day & Night
Backlight Compensation	Off / BLC
Contrast Enhancement	SSDR(SamsungSuperDynamicRange) (Off / On)
Digital Noise Reduction	SSNR(Off / On)
Motion Detection	Off / On (4ea rectangler zones)
Privacy Masking	Off / On (6ea rectangler zones)
Gain Control	Off / Low / Middle / High
White Balance	ATW / AWC / Manual / Indoor / Outdoor

This report shall not be reproduced except in full, without the written approval of KES Co., Ltd.  
The test results in the report only apply to the tested sample.



**KES Co., Ltd.**

C-3701, 40, Simin-daero 365beon-gil,  
 Dongan-gu, Anyang-si, Gyeonggi-do, 431-716, Korea  
 Tel: +82-31-425-6200 / Fax: +82-31-424-0450  
 www.kes.co.kr

Test report No.:  
 KES-E1-15T0077  
 Page (6) of (61)

LDC(Lens distortion control)	On/Off (5 levels with Min/Max)
Electronic Shutter Speed	Minimum / Maximum / Anti flicker
Flip / Mirror	Flip / Mirror / Hallway view
Intelligent Video Analytics	Motion Detection with metadata, Tampering
Alarm Triggers	Motiondetection, Tampering Detection, SD card error
Alarm Events	FileuploadviaFTPandE-Mail LocalstoragerecordingatEvent NotificationviaE-Mail
Network	
Ethernet	RJ-45 (10/100BASE-T)
Video Compression Format	H.264, MJPEG
Resolution	1280x1024/1280x960/ 1280x720 / 1024x768 / 800x600 / 720x576 / 640x480 / 320x240
Max. Framerate	H.264:Max30fpsatallresolutions MJPEG:Max1fpsat1280x1024/1280x960/1280x720,Max.15fpsatotherresolution
Video Quality Ajustment	H.264:TargetBitrateLevelControl MJPEG:QualityLevelControl
Bitrate control method	H.264:CBRorVBR MJPEG:VBR
Streaming Capability	Multiple Streaming(Up to 3 Profiles)
Audio I/O	Built-in Mic
Audio Compression Format	G.711u-law/G.726Selectable G.726(ADPCM)8KHz,G.7118KHz G.726:16Kbps,24Kbps,32Kbps,40Kbps
Audio Communication	Uni-directional
IP	IPv4, IPv6
Protocol	TCP/IP,UDP/IP,RTP(UDP),RTP(TCP),RTCP,RTSP,NTP,HTTP,HTTPS,SSL,DHCP,PPPoE,FTP,SMTP,ICMP,IGMP, ,SNMPv1/v2c/v3(MIB-2),ARP,DNS,DDNS,QoS,PIM-SM,UPnP,Bonjour
Security	HTTPS(SSL>LoginAuthentication DigestLoginAuthentication IPAddressFiltering UseraccessLog 802.1XAuthentication
Streaming Method	Unicast / Multicast
Max. User Access	6 users at Unicast Mode
Edge storage	MicroSD/SDHCMax32G,NAS (Motionimagesrecorded intheSDmemorycardcanbedownloaded)

This report shall not be reproduced except in full, without the written approval of KES Co., Ltd.  
 The test results in the report only apply to the tested sample.



**KES Co., Ltd.**

C-3701, 40, Simin-daero 365beon-gil,  
 Dongan-gu, Anyang-si, Gyeonggi-do, 431-716, Korea  
 Tel: +82-31-425-6200 / Fax: +82-31-424-0450  
 www.kes.co.kr

Test report No.:  
 KES-E1-15T0077  
 Page (7) of (61)

	(Manual recording at Local PC)
Application Programming Interface	ONVIF Profile S, G SUNAPI (HTTP API)
Webpage Language	English, French, German, Spanish, Italian, Chinese, Korean, Russian, Japanese, Swedish, Danish, Portuguese, Turkish, Polish, Czech, Rumanian, Serbian, Dutch, Croatia, Hungary, Greek, Finnish, Norwegian
Web Viewer	Supported OS: Windows XP/VISTA/7/8/8.1, MAC OS X 10.7~10.10 Supported Browser: Microsoft Internet Explorer (Ver. 8~11), Mozilla Firefox (Ver. 9~35), Google Chrome (Ver. 15~40), Apple Safari (Ver. 8.0.2 (Mac OS X 10.10), 8.0.2 (Mac OS X 10.9), 6.0.2 (Mac OS X 10.8, 10.7 only), 5.1.7) * Mac OS X only
Central Management Software	SmartViewer
Environmental	
Operating Temperature / Humidity	-10° C ~ +55° C / Less than 90% RH
Storage Temperature / Humidity	-30° C ~ +60° C (-22° F ~ +140° F) / Less than 90% RH
Ingress Protection	-
Vandal Resistance	-
Electrical	
Input Voltage / Current	PoE
Power Consumption	Max. 7.0W
Mechanical	
Color / Material	Ivory / Plastic
Dimension (WxHxD)	Φ119.8mm x 98mm
Weight	300g

This report shall not be reproduced except in full, without the written approval of KES Co., Ltd.  
 The test results in the report only apply to the tested sample.



### 1.3 Equipment Under Test

Description	Model Number	Serial Number	Manufacturer	Remarks
NETWORK CAMERA	SND-L6083RP	-	TIANJIN SAMSUNG TECHWIN OPTO-ELECTRONIC CO., LTD	E.U.T

### 1.4 Support Equipments

Description	Model Number	Serial Number	Manufacturer	Remarks
Notebook	NT63025J	JK9091EF40043 2X	SAMSUNG	-
AC/DC Adaptor	A13-040N2A	CN60BA440031 3AD0N843KO2 43	Chicony Power Technology (suzhou) Co., Ltd.	-
POE Switch	ANY4805C-LT1	10H300002	ANY ELECTRONICS CO., LTD	-
Micro SD Card	-	-	SANDISK	-

### 1.5 External I/O Cabling

Description	Length (m)	Port / From	Port/To	Remarks
NETWORK CAMERA	-	Micro SD slot / NETWORK CAMERA	Micro SD Card slot / Micro SD Card Card	-
NETWORK CAMERA	3.0	RJ-45 / NETWORK CAMERA	RJ-45 / POE Switch	Unshielded
POE Switch	3.0	RJ-45 / POE Switch	RJ-45 / Notebook	Unshielded

## 1.6 Special Accessories

As shown in section 1.8, all interface cables used for compliance testing are shielded as normally supplied or by use respective component manufacturers.

## 1.7 E.U.T Modifications

No modifications were made to the E.U.T in order to achieve and maintain compliance to the standards described in this report.

## 1.8 Configuration of Test System

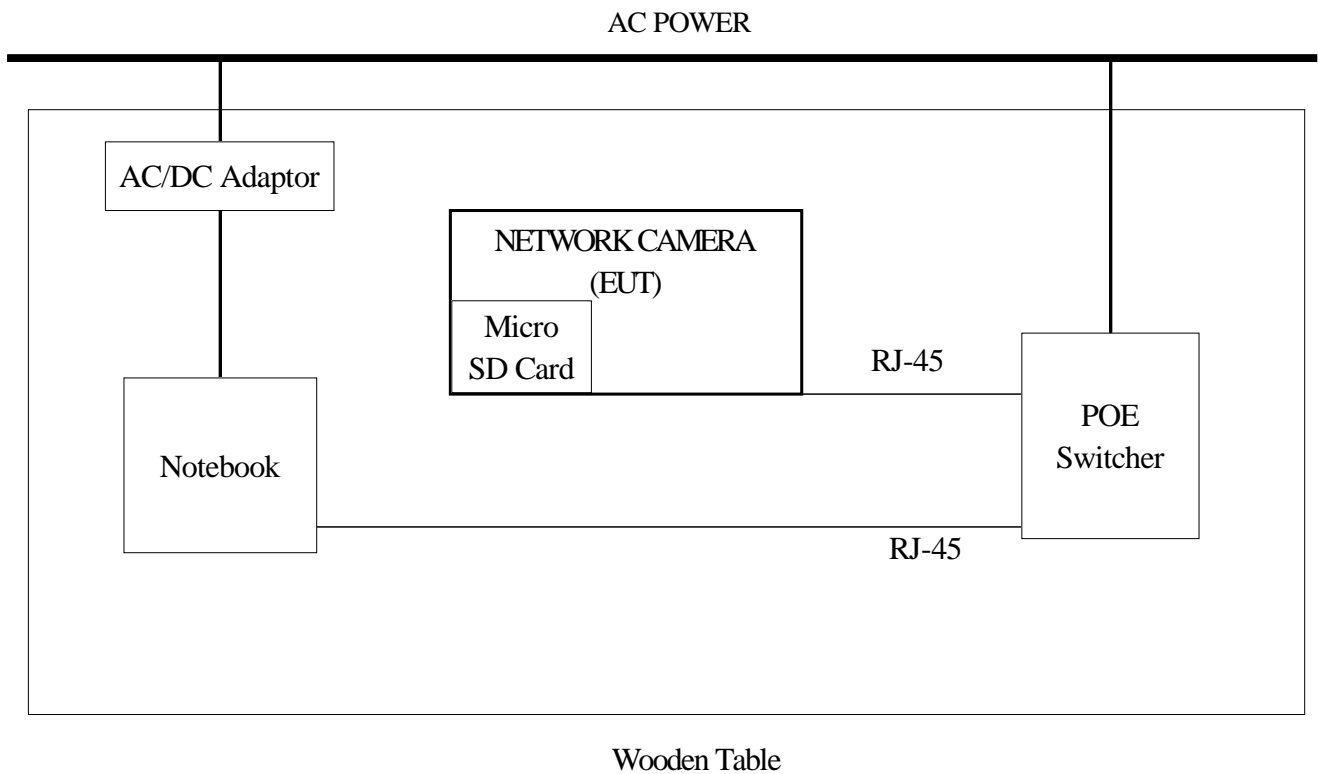

## 1.9 Operating condition :

- Ping test
- Web view monitoring

## 2. Product Labelling Requirements

### 2.1 CE Mark

The CE Conformity Marking must consist of the initials "CE" in the stylized font and proportional to the dimensional requirements shown in following figure. Regardless of its size, the symbol must retain the specified proportionality.

The Various components of the CE Marking must have substantially the same vertical dimensions, and shall not be less than 5mm in height.

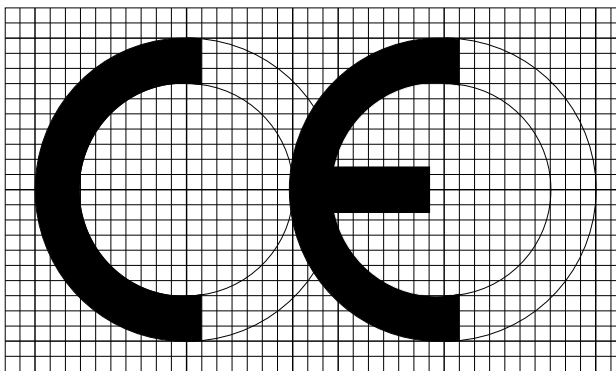

Radius of Outer Circle 100 units  
Radius of Inner Circle 70 units  
Stroke Width 30 units  
Length of Bar 85 units  
Axis to Axis 170 units  
Minimum Height 5.0 mm

### 2.2 Statements and User Information

Equipment classification, Class (A)

Directives in which conformance is claimed Applicable EN standards

Transitional provisions Class A equipment shall also include the following statement:

Warning:

This is a Class A product. In a domestic environment this product may cause radio interference in which case the user may be required to take adequate measures.

### 3. Applicable Regulations

#### 3.1 Emission

EN 55022:2010/CISPR22 are the applicable regulations that apply to Information Technology Equipment. The intention of these standards, is to establish uniform requirements for the radio disturbance level of the equipment contained in the scope, to fix limits of disturbance, to describe method of measurement and to standardize operation conditions and interpretation of the results.

EN 55022:2010/CISPR22 defines Information Technology Equipment (ITE) as follows:

Any equipment which has a primary function of either (or a combination of) entry, storage, display, retrieval, transmission, processing, switching, or control, of data and of telecommunication message and which may be equipped with one or more terminal ports typically operated for information transfer.

Any equipment with a rated supply voltage not exceeding 600 V (ac)

#### 3.2 Immunity

EN 50130-4:2011 Alarm systems-Part 4: Electromagnetic compatibility Product family standard: Immunity requirements for components of fire, intruder and social alarm systems

The variety and the diversity of the apparatus within the scope of this document makes it difficult to define precise criteria for the evaluation of the immunity test results.

If as a result of the application of the tests defined in this standard, the apparatus becomes dangerous or unsafe then the apparatus shall be deemed to have failed the test.

A functional description and a definition of performance by the manufacture and noted in the test report, based on the following criteria:

##### **Electrostatic discharge**

There shall be no damage, malfunction or change of status due to the conditioning.

Flickering of an indicator during the application of discharge is permissible, providing that is no residual change in the EUT or any change in outputs, which could be interpreted by associated equipment as a change.

##### **Radiated electromagnetic fields**

There shall be no damage, malfunction or change of status due to the conditioning.

Flickering of an indicator during the application of discharge is permissible, providing which could be interpreted by associated equipment as a change, and no such

Flickering of indicators occurs at a field strength of 3 V/m.

For components of CCTV systems, where the picture is allowed at 10 V/m, providing.

- (a) there is no permanent damage or change to EUT  
(e.g. no corruption of memory or changes to programmable setting etc.)
- (b) at 3 V/m, any deterioration of the picture is so minor that the system could still be used; and
- (c) there is no observable deterioration of the picture at 1 V/m.

### **Fast transient burst / slow high energy voltage surge**

There shall be no damage, malfunction or change of status due to the conditioning.

Flickering of an indicator during the application of discharge is permissible, providing

That there is no residual is permissible, providing that there is no residual change in the EUT or any change in outputs, which could be interpreted by associated equipment as a change.

### **Conducted RF immunity**

There shall be no damage, malfunction or change of status due to the conditioning.

Flickering of an indicator during the application of discharge is permissible, providing

That there is no residual is permissible, providing that there is no residual change in the EUT or any change in outputs, which could be interpreted by associated equipment as a change,

and no such flickering of indicators occurs at  $U = 130 \text{ dB}\mu\text{V}$ .

For component of CCTV systems, where the status is monitored by observing the TV picture, then deterioration of the picture is allowed at  $U = 140 \text{ dB}\mu\text{V}$ , providing:

- (a) there is no permanent damage or change to the EUT  
(e.g. no corruption of memory or changes to programmable settings etc.)
- (b) at  $U = 130 \text{ dB}\mu\text{V}$ , any deterioration of the picture is so minor that the system could still be used; and
- (c) there is no observable deterioration of the picture at  $U = 120 \text{ dB}\mu\text{V}$ .

**Voltage dip/interruption / Voltage variation**

There shall be no damage, malfunction or change of status due to the conditioning.

Flickering of an indicator during the conditioning is permissible, providing that there is no residual change in the EUT or any change in outputs, which could be interpreted by associated equipment as a change. The EUT shall meet the acceptance criteria for the functional test, after the conditioning.

#### 4. Test standards and results

STANDARDS		LIMIT	RESULTS
EN 55022	Conducted Emission on AC mains Port	Refer to EN 55022	N/A(1)
	Conducted Emission on Telecommunication Port	Refer to EN 55022	PASS
	Radiated Emission	Refer to EN 55022	PASS
EN 61000-3-2	Harmonic Current Emission on AC Mains Input Port	Refer to EN 61000-3-2	N/A(1)
EN 61000-3-3	Voltage Fluctuations and Flicker on AC Mains Input Port	Refer to EN 61000-3-3	N/A(1)
EN 50130-4	Electrostatic Discharge Immunity	Refer to EN 61000-4-2	PASS
	Radio-frequency electromagnetic field Amplitude modulated Immunity	Refer to EN 61000-4-3	PASS
	Fast Transients Immunity	Refer to EN 61000-4-4	PASS
	Surges Immunity	Refer to EN 61000-4-5	PASS
	Radio-frequency common mode Immunity	Refer to EN 61000-4-6	PASS
	Voltage Dips, Voltage Interruptions Immunity	Refer to EN 61000-4-11	N/A(1)
	Voltage Variations Immunity	Refer to EN 50130-4	N/A(1)

※ Note.

(1) N/A : This device is operate by 12 V (dc) and POE power. Test is not applicable.

## 5. Test Performed

### 5.1 Conducted Emission Measurements

#### 5.1.1 Test Description

The power line conducted emission measurements were performed in a shielded enclosure. The E.U.T was placed on a wooden table, 80 centimeters height above the floor. Power was fed to the E.U.T through a 50 ohm/ 50 micro henry Line Impedance Stabilization Network (LISN). The ground plane that was electrically bonded to the shield room ground system and all power lines entering the shield room were filtered.

#### 5.1.2 Test Equipments

Description	Manufacturer	Model Number	Serial Number	Cal. Due
EMI Receiver/Signal Analyzer	Narda S.T.S / PMM	PMM 9010F	020WW31006	04. 04. 2015
LISN	R&S	ENV216	101137	02. 10. 2016
LISN	EMCO	3810/2	2228	-
8-Wire ISN CAT3	Schwarzbeck Mess	CAT3 8158	8158-0019	04.08.2015
8-Wire ISN CAT5	Schwarzbeck Mess	NTFM 8158	8158-0030	05.21.2015
8-Wire ISN CAT6	Schwarzbeck Mess	NTFM 8158	8158-0029	08.15.2015
Electro wave Shieldroom	SEMITEC	-	-	-

#### 5.1.3 Test Environments

Ambient Temperatures	Relative Humidity
see the data	see the data

#### 5.1.4 Test Limits

- AC Main

Frequency (MHz)	EN 55022			
	Class B (dB $\mu$ V)		Class A (dB $\mu$ V)	
	Quasi-peak	Average	Quasi-peak	Average
0.15 to 0.50	66.0 to 56.0	56.0 to 46.0	79.0	66.0
0.50 to 5.00	56.0	46.0	73.0	60.0
5.00 to 30.00	60.0	50.0	73.0	60.0



- Telecommunication

Frequency (MHz)	EN 55022(Voltage)			
	Class B (dB $\mu$ V)		Class A (dB $\mu$ V)	
	Quasi-peak	Average	Quasi-peak	Average
0.15 to 0.50	84.0 to 74.0	74.0 to 64.0	97.0 to 87.0	84.0 to 74.0
0.50 to 30.00	74.0	64.0	87.0	74.0

Frequency (MHz)	EN 55022(Current)			
	Class B (dB $\mu$ A)		Class A (dB $\mu$ A)	
	Quasi-peak	Average	Quasi-peak	Average
0.15 to 0.50	40.0 to 30.0	30.0 to 20.0	53.0 to 43.0	40.0 to 30.0
0.50 to 30.00	30.0	20.0	43.0	30.0

**5.1.5 Test Procedure**

The conducted emission levels were measured on each current-carrying line with the spectrum analyzer operating in the CISPR quasi-peak mode (or peak mode if applicable). The analyzer's 6 dB bandwidth was set to 9 kHz. The initial step in collecting conducted data is a spectrum analyzer peak scan of the measurement range. If the conducted emission exceed the average limit with the instrument set to the quasi-peak mode, the measurements are made in the average mode. The emission spectrum was scanned from 150 kHz to 30 MHz. The highest emission amplitudes relative to the appropriate limits were measured and have been recorded. Quasi-peak readings are distinguished with a "QP".

The conducted emission test was performed with the E.U.T exercise program loaded, and the emissions were scanned between 150 kHz to 30 MHz on the HOT side and NEUTRAL side, herein referred to as H and N, respectively.

**5.1.6 Test Results**

According to the data in section 5.1.7, the E.U.T complied with the EN 55022/CISPR22 standards.



**5.1.7 Test Data**

\* AC Power

Temperature:      °C      Humidity:    % R.H.      Test Date:                      Tested by:

Polarization: HOT

N/A

This report shall not be reproduced except in full, without the written approval of KES Co., Ltd.  
The test results in the report only apply to the tested sample.



**KES Co., Ltd.**

C-3701, 40, Simin-daero 365beon-gil,  
Dongan-gu, Anyang-si, Gyeonggi-do, 431-716, Korea  
Tel: +82-31-425-6200 / Fax: +82-31-424-0450  
www.kes.co.kr

Test report No.:  
KES-E1-15T0077  
Page (18) of (61)

Polarization: NEUTRAL

N/A

This report shall not be reproduced except in full, without the written approval of KES Co., Ltd.  
The test results in the report only apply to the tested sample.

- Telecommunication

Temperature: 19.5 °C Humidity: 36.4 % R.H. Test Date: 03. 02. 2015 Tested by: Kang Hyeon, Kim

[10 Mbps]

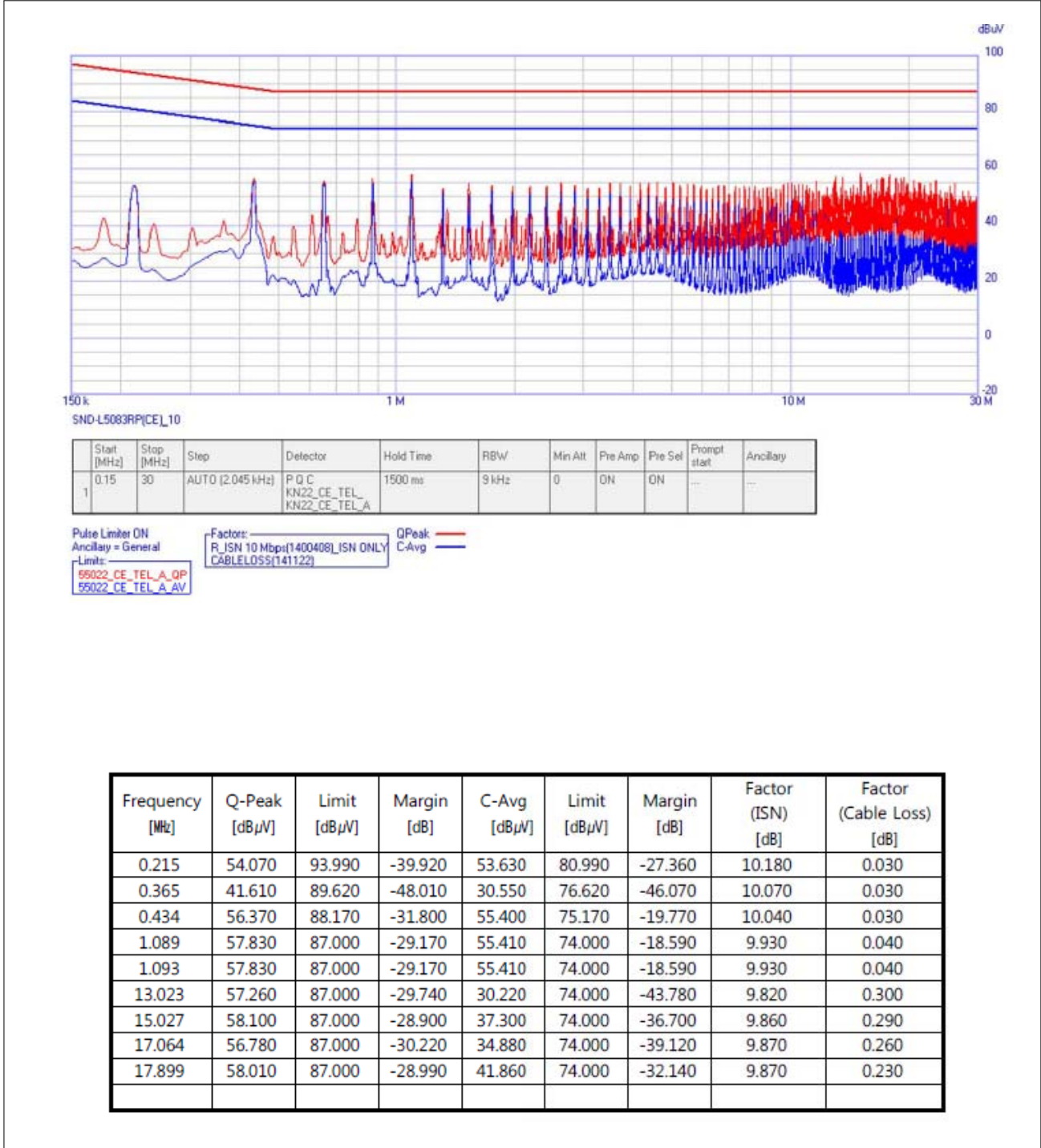

This report shall not be reproduced except in full, without the written approval of KES Co., Ltd.  
 The test results in the report only apply to the tested sample.

[100 Mbps]

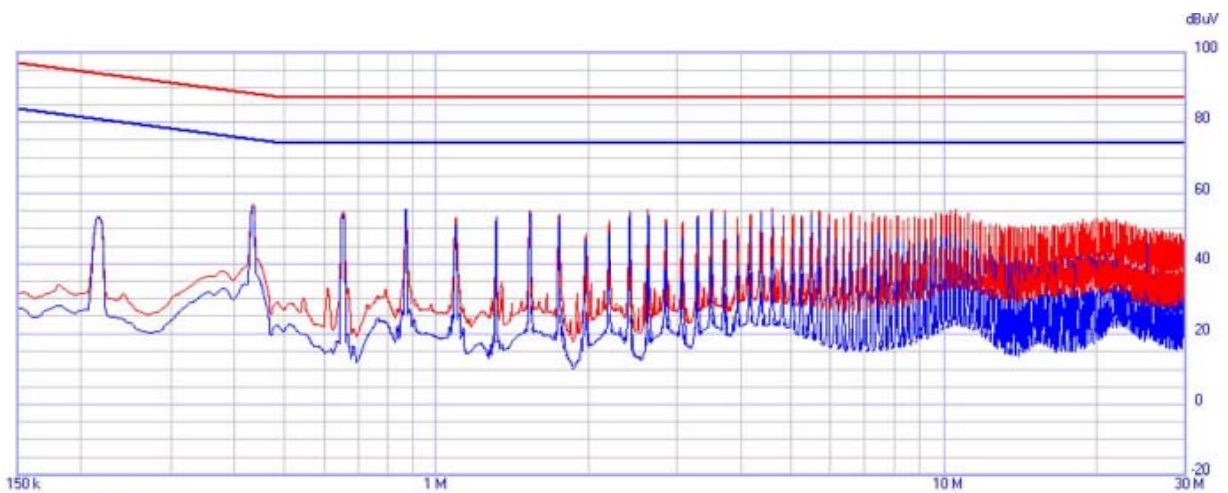

Start [MHz]	Stop [MHz]	Step	Detector	Hold Time	RBW	Min Aft	Pre Amp	Pre Sel	Prompt start	Ancillary
0.15	30	AUTO (2.045 kHz)	P Q C KN22_CE_TEL_ KN22_CE_TEL_A	1500 ms	91 Hz	0	ON	ON	---	---

Pulse Limiter ON  
 Ancillary = General  
 -Limits:  
 55022\_CE\_TEL\_A\_QP  
 55022\_CE\_TEL\_A\_AV

Factors:  
 R\_ISN 100 Mbps(1400521)\_ISN ONLY  
 CABLELOSS(141122)

QPeak ————  
 C-Avg ————

Frequency [MHz]	Q-Peak [dBμV]	Limit [dBμV]	Margin [dB]	C-Avg [dBμV]	Limit [dBμV]	Margin [dB]	Factor (ISN) [dB]	Factor (Cable Loss) [dB]
0.215	53.300	93.990	-40.690	52.970	80.990	-28.020	9.720	0.030
0.434	56.680	88.170	-31.490	55.970	75.170	-19.200	9.600	0.030
0.870	55.560	87.000	-31.440	55.350	74.000	-18.650	9.500	0.040
2.616	55.270	87.000	-31.730	54.110	74.000	-19.890	9.370	0.090
3.502	55.420	87.000	-31.580	54.950	74.000	-19.050	9.350	0.130
4.588	55.620	87.000	-31.380	54.150	74.000	-19.850	9.330	0.160
10.537	55.430	87.000	-31.570	48.410	74.000	-25.590	9.260	0.300

This report shall not be reproduced except in full, without the written approval of KES Co., Ltd.  
 The test results in the report only apply to the tested sample.

## 5.2 Radiated Emission Measurements

### 5.2.1 Test Description

The radiated emissions measurements were performed on the ten-meter open-field test site and 3 m full chamber. The E.U.T was placed on a nonconductive turntable approximately 0.8 meters above the ground plane.

The frequency spectrum from 30 MHz to 1 000 MHz and 1 000 MHz to 6 000 MHz was scanned and maximum emission levels at each frequency recorded.

The system was rotated 360°, and the antenna was varied in the height between 1.0 and 4.0 meters in order to determine the maximum emission levels. This procedure was performed for horizontal and vertical polarization of the receiving antenna.

- above 1 GHz : Antenna height is fixed to 1.0 m

\* Below 1 GHz

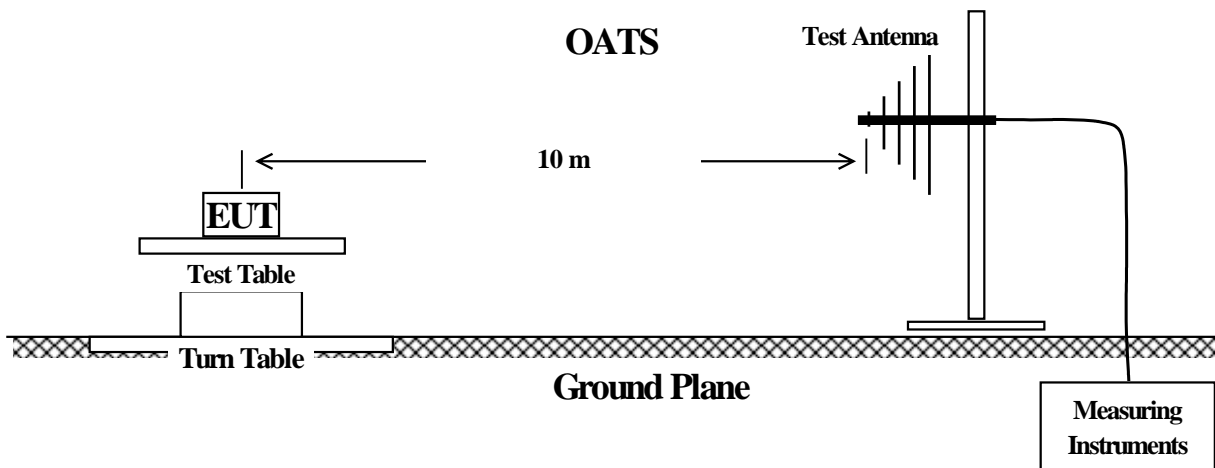

\* Above 1 GHz

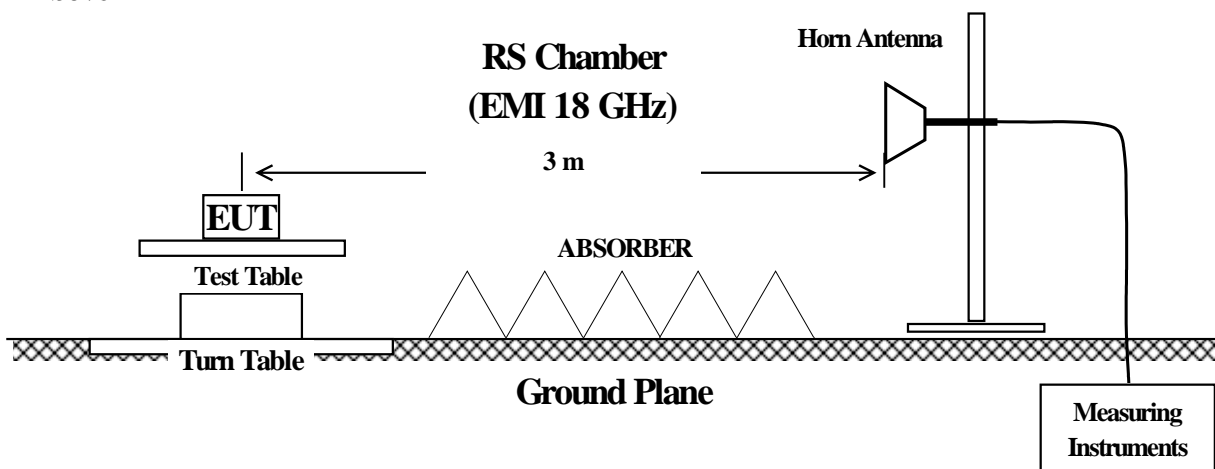

### 5.2.2 Test Equipments

Description	Manufacturer	Model Number	Serial Number	Cal. Due
EMI TEST Receiver	R & S	ESVS10	826008/014	04. 04. 2015
Trilog-Broadband Antenna	SCHWARZBECK	VULB 9168	9168-385	05. 09. 2015
OATS	KES	-	-	-
Antenna Mast	DAEIL EMC	-	-	-
Turn Table	DAEIL EMC	-	-	-
EMI TEST Receiver	R & S	ESR7	101190	08. 13. 2015
PREAMPLIFIER	8449B	H.P	3008A00538	07. 23. 2015
Double Ridged Horn Antenna	A-H-SYSTEM,INC	SAS-571	781	05. 13. 2015
RS Chamber (EMI 18GHz)	SEMITEC	-	-	-
Antenna Mast	AUDIX	-	-	-
Turn Table	AUDIX	-	-	-

### 5.2.3 Test Environments

Ambient Temperatures	Relative Humidity
see the data	see the data

### 5.2.4 Test Limits

Frequency (MHz)	EN 55022	
	Class B @ 10 m (dB $\mu$ V/m)	Class A @ 10 m (dB $\mu$ V/m)
30 to 230	30.0	40.0
230 to 1 000	37.0	47.0

Frequency (MHz)	EN 55022			
	Class B @ 3 m (dB $\mu$ V/m)		Class A @ 3 m (dB $\mu$ V/m)	
	PK	AV	PK	AV
1 000 to 3 000	70	50	76	56
3 000 to 6 000	74	54	80	60

### 5.2.5 Test Procedure

Before final measurements of radiated emission were made on the OATS, the E.U.T was scanned in semi-anechoic chamber in order to determine its emission spectrum signature. The physical arrangement of the test system and associated cabling was varied in order to determine the effect on the E.U.T's emission in amplitude, direction and frequency. This process was repeated during final radiated emission measurements on the OATS range, at each frequency, in order to ensure that maximum emissions amplitudes were attained.

The radiated emission test was performed with E.U.T exercise program loaded, and the emissions were scanned between 30 MHz to 6 000 MHz using the spectrum analyzer. The spectrum analyzer's 6 dB bandwidth was set to 120 kHz(1 MHz), and the analyzer was operated in the CISPR quasi-peak(Peak) detection mode.

Measurements were taken using both HORIZONTAL and VERTICAL antenna polarization, herein referred to as H and V, respectively.

### 5.2.6 Field Strength Calculation

F.S = Field Strength

M.R = Meter Reading

A.F = Antenna Factor

C.L = Cable Loss

A.G= Amplifier Gain

\* Below 1 GHz :  $F.S(dB\mu V/m) = M.R(dB\mu V) + [A.F(dB/m) + C.L(dB)]$

\* Above 1 GHz :  $F.S(dB\mu V/m) = M.R(dB\mu V) + [A.F(dB/m) + C.L(dB)] - A.G(35 dB)$

#### \* Measurement in the presence of high ambient signals

In general, the ambient signals should not exceed the limit. Radiated emanations from the EUT at the point of measurement may, however, be impossible to measure at some frequencies due to ambient noise fields generated by local broadcast services, other manmade devices, and natural sources.

a) Perform measurements at close-in distances and determine the limit L2 corresponding to the close-in distance d2 by applying the following relation:

$$L2 = L1 (d1/d2)$$

where L1 is the specified limit in microvolts per metre ( $\mu V/m$ ) at the distance d1.  
Determine the possible environmental and compliance test conditions stipulated in Clause 8 using L2 as the new limit for distance d2.

b) In the frequency bands where the ambient noise values of Clause 8 are exceeded (measured values higher than 6 dB below the limit), the disturbance values of the EUT may be interpolated from the adjacent disturbance values. The interpolated value shall lie on the curve describing a continuous function of the disturbance values adjacent to the ambient noise.





### 5.2.7 Test Results

According to the data in section 5.2.8, the E.U.T complied with the EN 55022/CISPR22 standards.

### 5.2.8 Test Data

**\* Below 1 GHz**

Temperature: 2.0 °C    Humidity: 57.0 % R.H.    Test Date: 03. 02. 2015    Tested by: Kang Hyeon, Kim

Frequency (MHz)	Amplitude (dB $\mu$ V/m)	Antenna		Correction Factor		Corrected Amplitude (dB $\mu$ V/m)	Applicable Limit (dB $\mu$ V/m)	Margin (dB)
		Polar. (H/V)	Height (m)	Ant. (dB)	Cable (dB)			
49.424	17.500	V	1.170	13.630	1.610	32.740	40.000	7.260
186.127	17.200	H	3.250	11.150	3.290	31.640	40.000	8.360
259.859	16.900	V	1.000	12.080	3.970	32.950	47.000	14.050
334.258	18.200	H	4.000	14.150	4.640	36.990	47.000	10.010
371.444	19.400	V	1.860	14.960	4.920	39.280	47.000	7.720
409.217	18.100	H	3.580	15.780	5.210	39.090	47.000	7.910
446.131	17.100	V	1.900	16.580	5.500	39.180	47.000	7.820
557.684	16.700	H	3.050	18.820	6.280	41.800	47.000	5.200

This report shall not be reproduced except in full, without the written approval of KES Co., Ltd.  
The test results in the report only apply to the tested sample.

**\* Above 1 GHz**

Temperature: 19.5 °C Humidity: 36.4 % R.H. Test Date: 03. 02. 2015 Tested by: Kang Hyeon, Kim

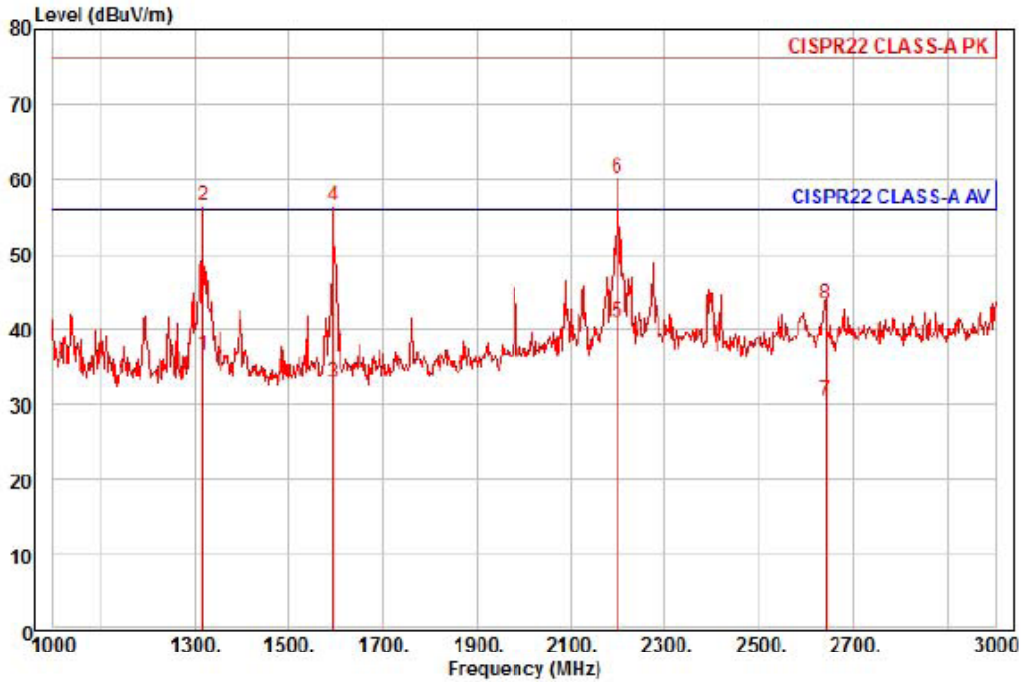

Site : chamber  
 Condition: CISPR22 CLASS-A PK 3m HORN ANT (2014.03.10) horizontal  
 : RBW:1000.000kHz VBW:1000.000kHz SWT:Auto  
 Project : NETWORK CAMERA  
 EUT : SND-L5083R  
 Mode : CE  
 Memo : 1 - 3 GHz

	Read	Ant	Cable	Preamp	TPos	Limit	Over		
Freq	Level	Factor	Loss	Factor		Line	Limit	Pol/Phase	Remark
MHz	dBuV	dB/m	dB	dB	deg	dBuV/m	dB		
1	1320.00	41.79	24.29	6.21	35.67	223	56.00	-19.38	horizontal Average
2	1320.00	61.58	24.29	6.21	35.67	223	76.00	-19.59	horizontal Peak
3	1594.00	35.67	25.62	6.88	35.21	177	56.00	-23.04	horizontal Average
4	1594.00	59.10	25.62	6.88	35.21	177	76.00	-19.61	horizontal Peak
5 pp	2200.00	38.52	28.62	8.28	34.39	218	56.00	-14.97	horizontal Average
6 pk	2200.00	57.56	28.62	8.28	34.39	218	76.00	-15.93	horizontal Peak
7	2642.00	25.76	29.54	9.21	34.09	68	56.00	-25.58	horizontal Average
8	2642.00	38.68	29.54	9.21	34.09	68	76.00	-32.66	horizontal Peak

This report shall not be reproduced except in full, without the written approval of KES Co., Ltd.  
 The test results in the report only apply to the tested sample.

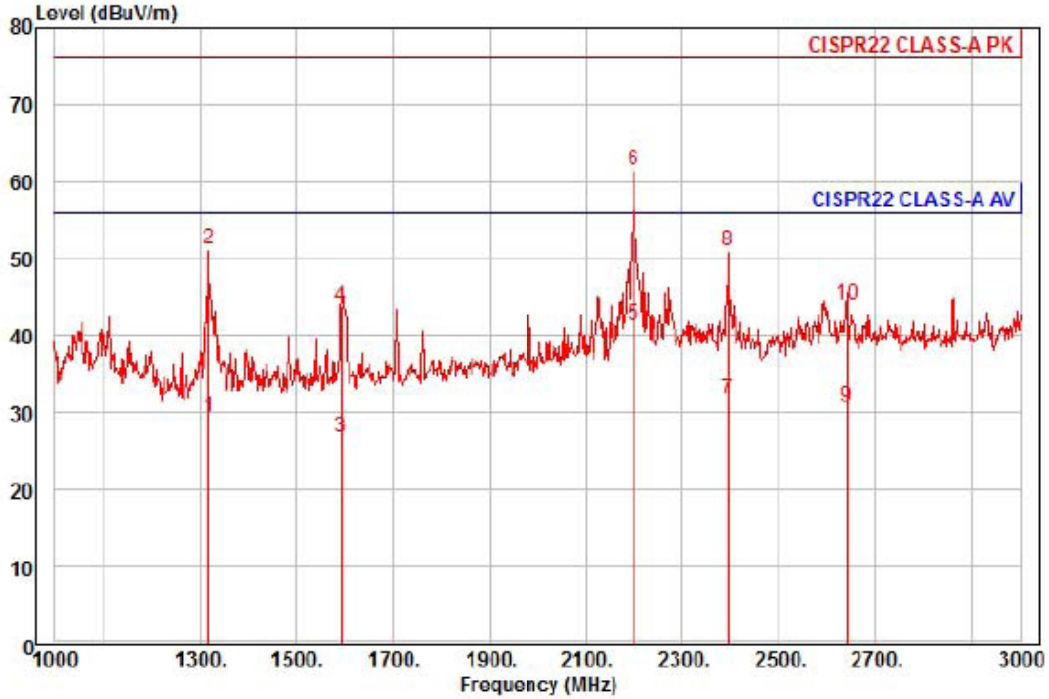

Site : chamber  
 Condition: CISPR22 CLASS-A PK 3m HORN ANT (2014.03.10) vertical  
 : RBW:1000.000kHz VBW:1000.000kHz SWT:Auto  
 Project : NETWORK CAMERA  
 EUT : SND-L5083R  
 Mode : CE  
 Memo : 1 - 3 GHz

	Freq	Read Level	Ant Factor	Cable Loss	Preamp Factor	TPos	Limit Line	Over Limit	Pol/Phase	Remark
	MHz	dBuV	dB/m	dB	dB	deg	dBuV/m	dB		
1	1320.00	34.62	24.29	6.21	35.67	9	56.00	-26.55	vertical	Average
2	1320.00	56.48	24.29	6.21	35.67	9	76.00	-24.69	vertical	Peak
3	1592.00	29.50	25.60	6.87	35.21	43	56.00	-29.24	vertical	Average
4	1592.00	46.56	25.60	6.87	35.21	43	76.00	-32.18	vertical	Peak
5 av	2200.00	38.86	28.62	8.28	34.39	32	56.00	-14.63	vertical	Average
6 pp	2200.00	59.00	28.62	8.28	34.39	32	76.00	-14.49	vertical	Peak
7	2396.00	28.27	29.04	8.69	34.26	223	56.00	-24.26	vertical	Average
8	2396.00	47.62	29.04	8.69	34.26	223	76.00	-24.91	vertical	Peak
9	2642.00	26.16	29.54	9.21	34.09	86	56.00	-25.18	vertical	Average
10	2642.00	39.41	29.54	9.21	34.09	86	76.00	-31.93	vertical	Peak

This report shall not be reproduced except in full, without the written approval of KES Co., Ltd.  
 The test results in the report only apply to the tested sample.

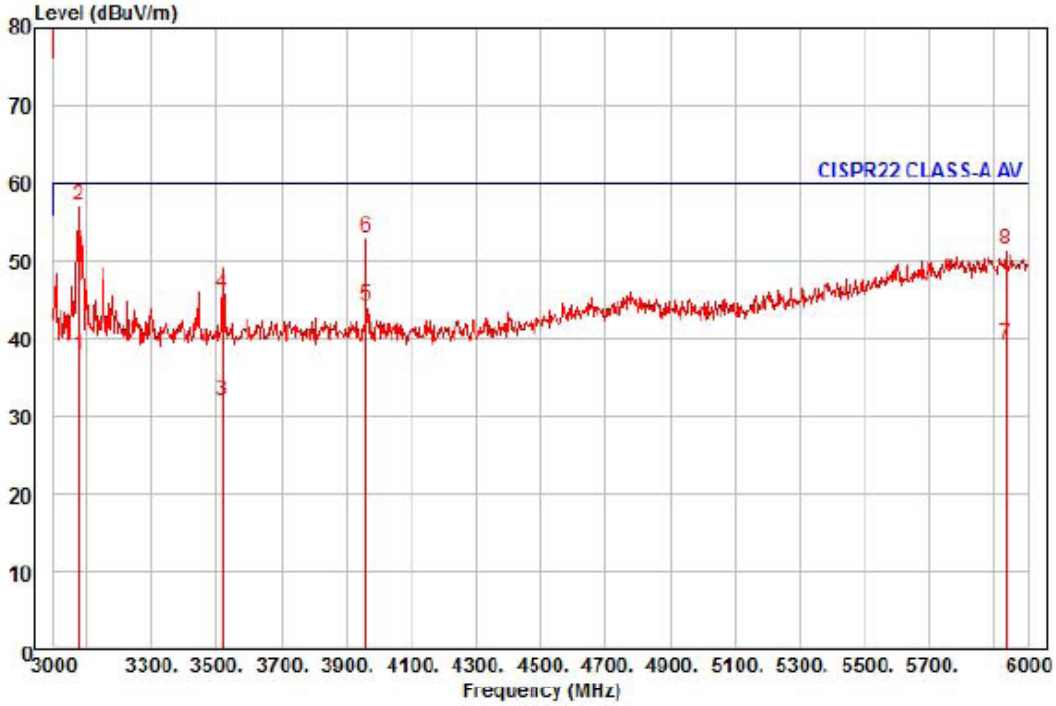

Site : chamber  
 Condition: CISPR22 CLASS-A PK 3m HORN ANT (2014.03.10) horizontal  
 : RBW:1000.000kHz VBW:1000.000kHz SWT:Auto  
 Project : NETWORK CAMERA  
 EUT : SND-L5083R  
 Mode : CE  
 Memo : 3 - 6 GHz

	Read	Ant	Cable	Preamp	TPos	Limit	Over		
Freq	Level	Factor	Loss	Factor		Line	Limit	Pol/Phase	Remark
MHz	dBuV	dB/m	dB	dB	deg	dBuV/m	dB		
1	3078.00	31.49	30.28	10.08	33.93	132	60.00	-22.08	horizontal Average
2 pk	3078.00	50.58	30.28	10.08	33.93	132	80.00	-22.99	horizontal Peak
3	3519.00	25.29	30.49	10.77	34.43	312	60.00	-27.88	horizontal Average
4	3519.00	38.86	30.49	10.77	34.43	312	80.00	-34.31	horizontal Peak
5 pp	3960.00	35.96	31.80	11.46	34.92	219	60.00	-15.70	horizontal Average
6	3960.00	44.52	31.80	11.46	34.92	219	80.00	-27.14	horizontal Peak
7	5934.00	20.19	35.07	17.34	33.34	42	60.00	-20.74	horizontal Average
8	5934.00	32.40	35.07	17.34	33.34	42	80.00	-28.53	horizontal Peak

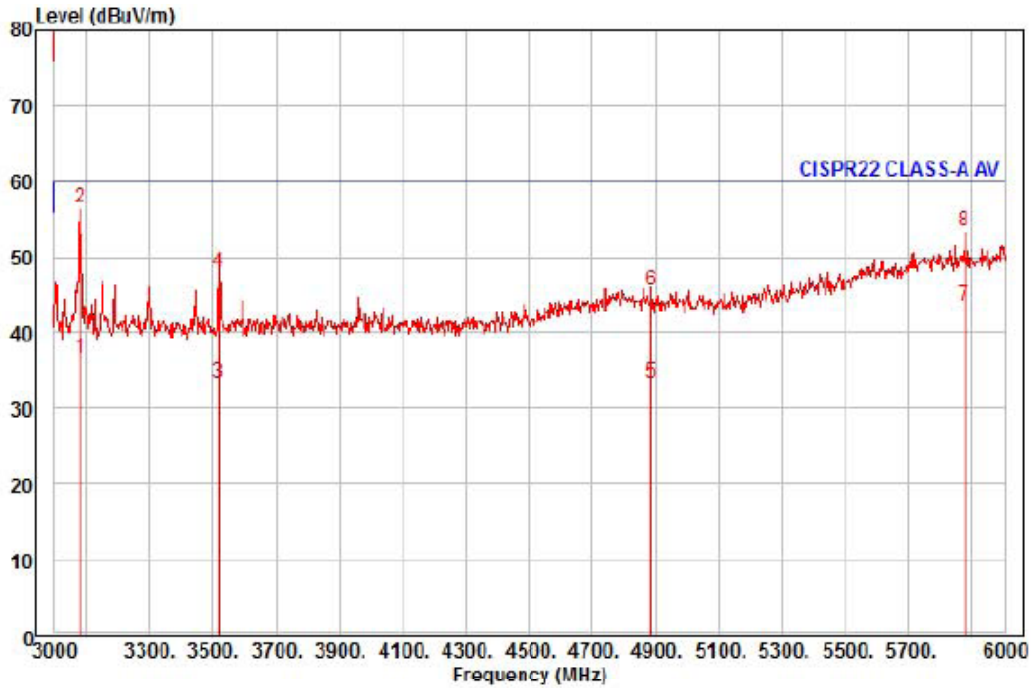

Site : chamber  
 Condition: CISPR22 CLASS-A PK 3m HORN ANT (2014.03.10) vertical  
 : RBW:1000.000kHz VBW:1000.000kHz SWT:Auto  
 Project : NETWORK CAMERA  
 EUT : SND-L5083R  
 Mode : CE  
 Memo : 3 - 6 GHz

	Read	Ant	Cable	Preamp	TPos	Limit	Over			
Freq	Level	Factor	Loss	Factor		Line	Limit	Pol/Phase	Remark	
MHz	dBuV	dB/m	dB	dB	deg	dBuV/m	dB			
1	3081.00	30.18	30.28	10.09	33.93	122	60.00	-23.38	vertical	Average
2	pk 3081.00	49.92	30.28	10.09	33.93	122	80.00	-23.64	vertical	Peak
3	3519.00	26.44	30.49	10.77	34.43	268	60.00	-26.73	vertical	Average
4	3519.00	41.04	30.49	10.77	34.43	268	80.00	-32.13	vertical	Peak
5	4887.00	20.49	33.35	12.98	33.41	334	60.00	-26.59	vertical	Average
6	4887.00	32.60	33.35	12.98	33.41	334	80.00	-34.48	vertical	Peak
7	pp 5877.00	24.98	34.89	17.09	33.33	247	60.00	-16.37	vertical	Average
8	5877.00	34.85	34.89	17.09	33.33	247	80.00	-26.50	vertical	Peak

### 5.3 Harmonics / Voltage Fluctuations Measurements

#### 5.3.1 Test Description

Harmonics of the fundamental current were measured up to 2 kHz using a universal power analyzer. The measurements were carried out under steady conditions and using averaging.

Before making measurements the class of the E.U.T has been evaluated, it is necessary for the E.U.T to decide which class the E.U.T fulfills into; A, B, C or D

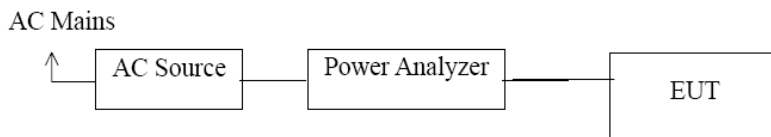

#### 5.3.2 Test Equipments

Description	Manufacturer	Model Number	Serial Number	Cal. Due
AC Source	EM test	ACS 500 N	V1024106760	08. 13. 2015
Digital Power Analyzer	EM test	DPA 500 N	V1024106759	08. 13. 2015

#### 5.3.3 Test Environments

Ambient Temperatures : -  
Relative Humidity : -

#### 5.3.4 Test Procedures

The E.U.T was installed and placed on a non-conductive table and was connected to the AC power source, 230 V (ac), 50 Hz via the measuring equipment with its attached AC power cord. All other equipment or peripherals included in the test, and having a separate power supply, are connected to the outlet, supplying 230 V (ac), 50 Hz. A typical configuration is defined in the specification ANSI 63.4 or CISPR22. This ensures the repeatability of the test.

The E.U.T is set in operation and was monitored for measurements with the software, supplied by test equipment manufacturer. An EMC test program provided by client was used to exercise the E.U.T.





Test Data - Harmonics (continued)

<i>Maximum harmonic voltage results</i>				
Hn	I <sub>eff</sub> [A]	U <sub>eff</sub> [%]	Limit [%]	Result
1			N/A	
2				
3				
4				
5				
6				
7				
8				
9				
10				
11				
12				
13				
14				
15				
16				
17				
18				
19				
20				
21				
22				
23				
24				
25				
26				
27				
28				
29				
30				
31				
32				
33				
34				
35				
36				
37				
38				
39				
40				

This report shall not be reproduced except in full, without the written approval of KES Co., Ltd.  
The test results in the report only apply to the tested sample.



### 5.3.7 Test Data - Voltage Fluctuations

## Maximum Flicker results

	<b>E.U.T values</b>	<b>Limit</b>	<b>Result</b>
Pst	N/A		
Plt			
dc [%]			
dmax [%]			
dt [s]			

## 5.4 Electrostatic Discharge Immunity

### 5.4.1 Test Description

The E.U.T and all local support equipment were placed on non-metallic support 0.8 m above a reference ground plane (RGP) and was put into operation according to the specified operating mode.

### 5.4.2 Test Equipments

Description	Manufacturer	Model Number	Serial Number	Cal. Due
ESD SIMULATOR	Noise Ken	ESS-2000	ESS05X4620	06.30.2015

### 5.4.3 Test Environment

Ambient Temperatures :	15 °C ~ 35 °C
Relative Humidity :	25 % R.H. ~ 75 % R.H.
Atmospheric Pressure :	86.0 kPa ~ 106.0 kPa

### 5.4.4 Test Levels

Discharge Impedance :	330 Ω ± 10 % / 150 pF ± 10 %
Type of Discharge :	Direct - Air Discharge (± 2 kV & ± 4 kV & ± 8 kV), Contact Discharge (± 6 kV) Indirect - HCP Discharge (± 2 kV & ± 4 kV & ± 6 kV) VCP Discharge (± 2 kV & ± 4 kV & ± 6 kV)
Polarity of Output Voltage :	Positive and Negative
Discharge Repetition Rate :	1/sec
Number of Discharges :	more than 10 times
Performance Criteria :	B

### 5.4.5 Test Procedure

Test programs and software were chosen so as to exercise all normal modes of operation of the E.U.T. The use of special exercising software is encouraged, but permitted only where it can be shown that the E.U.T is being comprehensively exercised.

The test was conducted in the following order: Air Discharge, Direct Contact Discharge, Indirect Contact Horizontal Coupling Plane (HCP) Discharge, and Indirect Contact Vertical Coupling Plane (VCP) Discharge. The electrostatic discharge test levels were set and discharges for the different test modes were set appropriately. The electrostatic discharge is applied to the conductive surface of the E.U.T, and along all seams and control surfaces on the E.U.T. When a discharge occurs and an error is caused, the type of error, discharge level and location is recorded.

**5.4.6 Test Results**

According to the data in section 5.4.7, the E.U.T complied with the EN 61000-4-2 standards, and detailed test results are found in the following test data.

**5.4.7 Test Data**

Temperature: 18.3 °C Humidity: 34.0 % R.H. Test Date: 03. 03. 2015 Tested by: Kang Hyeon, Kim

Indirect Discharge

No.	Test Point	Discharge Method	Performance		Remarks
			Test level	Results	
1	HCP Contact	Contact Discharge	± (2,4,6 ) kV	Complied	-
2	VCP Contact	Contact Discharge	± (2,4,6 ) kV	Complied	-

Direct Discharge

No.	Test Point	Discharge Method	Performance		Remarks
			Test level	Results	
1	NO Discharge Point	-	± (2,4,6 ) kV	-	-

10 times Indirect discharge test for each polarity.

## 5.5 Radio-frequency electromagnetic field Amplitude modulated Immunity

### 5.5.1 Test Description

The E.U.T and all local support equipment were placed on a non-metallic support 0.8 m above a reference ground plane (RGP) and was put into operation according to the specified operating mode.

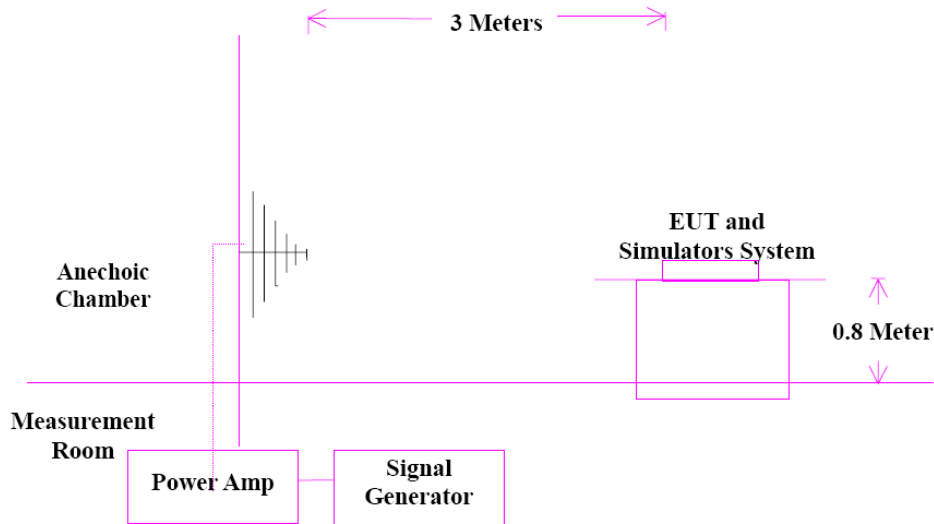

### 5.5.2 Test Equipments

Description	Manufacturer	Model Number	Serial Number	Cal. Due
Average Power Sensor	Agilent	E9301A	MY41498011	08.13.2015
Average Power Sensor	Agilent	E9301A	-	08.13.2015
Signal Generator	HP	ESG-3000A	US37040210	08.13.2015
Power Meter	Agilent	E4419B	MY45101506	08.13.2015
Power Amplifier	Infinitech	ITA0300-200	-	08.13.2015
Power Amplifier	Infinitech	ITA0750-200	-	08.13.2015
Power Amplifier	Infinitech	ITA1500-100	-	08.13.2015
Power Amplifier	Infinitech	ITA2500-100	-	08.13.2015
Stacked Log.-Per.Antenna	Schwarzbeck	STLP 9128 D	9128D038	-
RS Chamber(EMI 18GHz)	SEMITEC	-	-	-

### 5.5.3 Test Environments

Ambient Temperatures :	15 °C ~ 35 °C
Relative Humidity :	25 % R.H. ~ 75 % R.H.
Atmospheric Pressure :	86.0 kPa ~ 106.0 kPa

### 5.5.4 Test Levels

Frequency Range :	80 MHz to 2 700 MHz
Field Strength :	10 V/m(3 V/m, 1 V/m)
Modulation :	80 % Amplitude Modulation (1 kHz) Pulse Modulation (1 Hz (0.5 s ON: 0.5 s OFF))
Distance of ANT-E.U.T :	3 meters
Antenna Polarity :	Horizontal and Vertical
Frequency Step :	1 %
Performance Criteria :	A

### 5.5.5 Test Procedures

The E.U.T is set into operation and was monitored for variations in performance. The test signal start frequency (80 MHz) and stop frequency (2 700 MHz) were set, including the field strength at 10 V/m(3 V/m, 1 V/m), 80 % modulated through immunity test software. The software maintains the necessary field strength through the frequency range, with the transmitting antenna horizontally polarized. If an error is detected, the field is reduced until the error is not repeatable, the field is then manually increased until the error begins to occur. This threshold level, the frequency and the error created are noted before continuing. The test is then repeated with vertical polarization, using the same test configuration for all four sides.

### 5.5.6 Test Results

According to the data in section 5.5.7, the E.U.T complied with the EN 61000-4-3 standards, and detailed test results are found in the following test data.

**5.5.7 Test Data**

Temperature: 18.3 °C Humidity: 34.0 % R.H. Test Date: 03. 03. 2015 Tested by: Kang Hyeon, Kim

No.	Test Point	Performance Results		Remarks
		Horizontal	Vertical	
1	Front	Complied	Complied	-
2	Rear	Complied	Complied	-
3	Right Side	Complied	Complied	-
4	Left Side	Complied	Complied	-

## 5.6 Fast Transient Immunity

### 5.6.1 Test Description

The E.U.T and all local support equipment were placed a non-metallic support 0.8 m above a reference ground plane (RGP) and was put into operation according to the specified operating mode. If the E.U.T has a non-detachable supply cable more than 1 m long, the excess length of this cable was gathered into a flat coil with a 0.4 m diameter and situated at a distance of 0.1 m above the RGP.

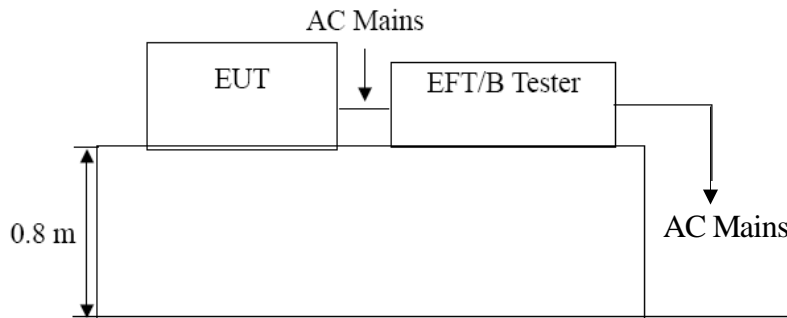

### 5.6.2 Test Equipments

Description	Manufacturer	Model Number	Serial Number	Cal. Due
Transient Test System	TRA3000F-S-D-V	EMC PARTNER AG	1524	04. 04. 2015
MotorVariac	VAR-EXT1000	EMC PARTNER AG	1507	04. 04. 2015
Capacitive Coupling clamp	CN-EFT1000	EMC PARTNER AG	1528	04. 04. 2015

### 5.6.3 Test Environments

Ambient Temperatures : 15 °C ~ 35 °C  
 Relative Humidity : 25 % R.H. ~ 75 % R.H.  
 Atmospheric Pressure : 86.0 kPa ~ 106.0 kPa

#### 5.6.4 Test Levels

Open Circuit Output Test Voltage :	<input type="checkbox"/> Power Supply AC; $\pm 2$ kV <input type="checkbox"/> Power Supply DC; $\pm 1$ kV <input checked="" type="checkbox"/> I/O Signal, Data and Control ports; $\pm 1$ kV
Repetition Frequency of the Impulses :	100 kHz
Polarity :	Positive and Negative
Rise Time of One Pulse :	5 ns $\pm 30$ %
Impulse Duration :	50 ns $\pm 30$ %
Burst Duration :	15 ms $\pm 20$ %
Burst Period :	300 ms $\pm 20$ %
Performance Criteria :	B

#### 5.6.5 Test Procedure

The E.U.T was connected to the test equipment, and monitored for performance. The test level was set and the test signal was applied for 200 seconds. A test signal of  $\pm 1$  kV, and  $\pm 2$  kV was Coupled to Line and Ground, Neutral and Ground, Line plus Neutral and Ground, and Protective Earth and Ground. When an error occurs, the test level is reduced until the error recovers and then increased until the threshold level is reached. This threshold and the error conditions were noted. This procedure was then repeated for the other coupling modes.

#### 5.6.6 Test Results

According to the data in section 5.6.7, the E.U.T complied with the EN61000-4-4 standards, and detailed test results are found in the following test data.



**5.6.7 Test Data**

Temperature: 18.3 °C Humidity: 34.0 % R.H. Test Date: 03.03.2015 Tested by: Kang Hyeon, Kim

On AC Power Supply

No.	Test Point	Test Level	Performance Results		Remarks
			+Burst	-Burst	
1	-	± 2 kV	-	-	
2	-	± 2 kV	-	-	
3	-	± 2 kV	-	-	

On DC Power Supply

No.	Test Point	Test Level	Performance Results		Remarks
			+Burst	-Burst	
1	-	± 1 kV	-	-	-
2	-	± 1 kV	-	-	-
3	-	± 1 kV	-	-	-

On I/O Signal, Data and Control ports

No.	Test Point	Test Level	Performance Results		Remarks
			+Burst	-Burst	
1	RJ-45	± 1 kV	Complied	Complied	-

## 5.7 Surge Immunity

### 5.7.1 Test Description

The E.U.T and all local support equipment was placed on a non-metallic support 0.8 m above a reference ground plane (RGP) and was put into operation according to the specified operating mode.

### 5.7.2 Test Equipments

Description	Manufacturer	Model Number	Serial Number	Cal. Due
Ultra Compact Simulator	EM TEST	UCS 500 N5	V0936105120	08. 14. 2015
MotorVariac	EM TEST	MV2616	V0936105123	08. 13. 2015
CDN	EM TEST	CNV 504N	V0936105121	-

### 5.7.3 Test Environments

Ambient Temperatures :	15 °C ~ 35 °C
Relative Humidity :	25 % R.H. ~ 75 % R.H.
Atmospheric Pressure :	86.0 kPa ~ 106.0 kPa

### 5.7.4 Test Levels

Open Circuit Test Voltage :	<input type="checkbox"/> AC Power; ± 0,5 kV & ± 1 kV line-to-line, <input type="checkbox"/> AC Power, ± 0,5 kV & ± 1 kV & ± 2 kV line-to-ground <input type="checkbox"/> DC Power; ± 0,5 kV & ± 1 kV line-to-ground <input checked="" type="checkbox"/> Data and Control Line; ± 0,5 kV & ± 1 kV line-to-ground
Open Circuit Voltage Waveform :	1.2/50 microsecond
Short Circuit Current Waveform :	8/20 microsecond
Number of Tests :	5 positive and 5 negative
Repetition Rate :	1/min
Performance Criteria :	B

### 5.7.5 Test Procedure

The surges have to be applied line to line and line(s) and ground. In case of testing line to ground the test voltage has to be applied successively between each of the lines and ground, if there is no other specification. All lower levels including the selected test level must be satisfied. For testing the secondary protection the output voltage of the generator must be increased up to the worst case voltage break down level of the primary protection.

**5.7.6 Test Results**

According to the data in section 5.7.7, the E.U.T complied with the EN61000-4-5 standards, and detailed test results are found in the following test data.

**5.7.7 Test Data**

Temperature: 18.3 °C Humidity: 34.0 % R.H. Test Date: 03.03.2015 Tested by: Kang Hyeon, Kim

On DC Power Supply

No.	Test Point	Test Level	Performance Results		Remarks
			+Surge	-Surge	
1	L1-L2	± (0,5 & 1) kV	-	-	-

On I/O Signal, Data and Control ports

No.	Test Point	Test Level	Performance Results		Remarks
			+Surge	-Surge	
1	RJ-45	± (0,5 & 1) kV	Complied	Complied	-

## 5.8 Radio-frequency continuous conducted Immunity

### 5.8.1 Test Descriptions

The E.U.T and all local support equipment were placed on a non-metallic support 0.1 m above a reference ground plane (RGP) and was put into operation according to the specified operating mode.

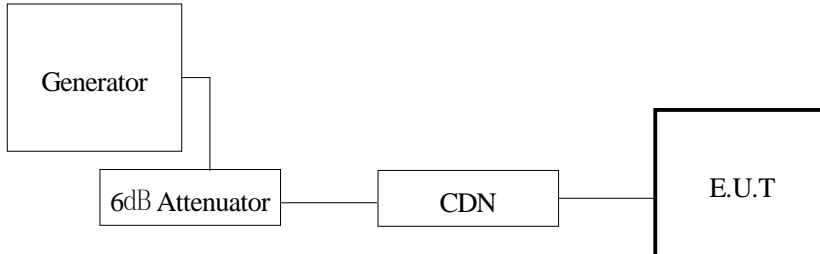

### 5.8.2 Test Equipments

Description	Manufacturer	Model Number	Serial Number	Cal. Due
Continuous Wave Simulator	EM TEST	CWS 500N1	V0936105119	08. 14. 2015
6dB Attenuator	EM TEST	ATT6	1208-34	08. 13. 2015
CDN	EM TEST	CDN-M2/M3N	0909-06	08. 13. 2015
EM Injection Clamp	EM TEST	EM 101	36152	05. 14. 2015

### 5.8.3 Test Environments

Ambient Temperatures :	15 °C ~ 35 °C
Relative Humidity :	25 % R.H. ~ 75 % R.H.
Atmospheric Pressure :	86.0 kPa ~ 106.0 kPa

### 5.8.4 Test Levels

Frequency Range :	150 kHz to 100 MHz
Voltage Level :	10 V(3 V, 1 V)
Modulation :	80 % Amplitude Modulation (1 kHz) Pulse Modulation (1 Hz (0.5 s ON: 0.5 s OFF))
Frequency Step :	1 %
Performance Criteria :	A

**5.8.5 Test Procedure**

The test was performed with the test generator connected to each of the coupling and decoupling devices in turn while the other non-excited RF-input ports of the coupling devices are terminated by a 50 Ω load resistor. The frequency range is swept from 150 kHz to 100 MHz, using the signal levels established during the setting process, and with the disturbance signal 80 % amplitude modulated with a 1kHz sine wave, pausing to adjust the RF-signal level or to switch coupling device as necessary.

**5.8.6 Test Results**

According to the data in section 5.8.7, the E.U.T complied with the EN61000-4-6 standards, and detailed test results are found in the following test data.

**5.8.7 Test Data**

Temperature: 18.3 °C Humidity: 34.0 % R.H. Test Date: 03.03.2015 Tested by: Kang Hyeon, Kim

On AC Power Supply

No.	Test Point	Performance		Remarks
		Coupling method	Results	
1	-	CDN	-	-

On DC Power Supply

No.	Test Point	Performance		Remarks
		Coupling method	Results	
1	-	CDN	-	-

On I/O Signal, Data and Control ports

No.	Test Point	Performance		Remarks
		Coupling method	Results	
1	RJ-45	EM Clamp	Complied	-

## 5.9 Voltage Dips and Voltage Interruptions Immunity Measurements

### 5.9.1 Test Descriptions

The E.U.T and all local support equipment was placed on a non-metallic support 0.8 m above a reference ground plane (RGP) and was put into operation according to the specified operating mode.

### 5.9.2 Test Equipments

Description	Manufacturer	Model Number	Serial Number	Cal. Due
Ultra Compact Simulator	EM TEST	UCS 500 N5	V0936105120	08.13.2015
MotorVariac	EM TEST	MV2616	V0936105123	08.13.2015

### 5.9.3 Test Environments

Ambient Temperatures :	15 °C ~ 35 °C
Relative Humidity :	25 % R.H. ~ 75 % R.H.
Atmospheric Pressure :	86.0 kPa ~ 106.0 kPa

### 5.9.4 Test Levels

Overshoot/Undershoot of Actual Voltage :	Less than $\pm 5$ % of the change in voltage
Voltage Rise and Fall Time :	Between 1 and 5 microseconds
Test Voltage / Test Frequency :	230 V (ac) / 50 Hz
Frequency Deviation of Test Voltage :	Less than $\pm 2$ % of rated frequency
Number of Tests :	3 times
Test Intervals :	10 sec
Performance Criteria :	B for Voltage Dips C for Voltage Short Interruptions A for Voltage Variation

### 5.9.5 Test Procedure

For each test any degradation of performance were recorded. The monitoring equipment should be capable of displaying the status of the operational mode of the E.U.T during and after the tests. After each group of tests a full functional check were performed.



### 5.9.6 Test Results

N/A : The EUT is non magnetic fields to which equipment, test is not applicable

### 5.9.7 Test Data

Temperature:      °C      Humidity:      % R.H.      Test Date:      Tested by:

#### Voltage Dips(AC Power Supply)

No.	Depth	Duration	Results	Remarks
1	20 %	250T	-	-
2	30 %	25T	-	-
3	60 %	10T	-	-
4	100 %	250T	-	-

#### Voltage variations(AC Power Supply)

No.	Test Level		Results	Remarks
1	Unom + 10 %	253 V (ac)	-	-
2	Unom - 15 %	195.5 V (ac)	-	-

This report shall not be reproduced except in full, without the written approval of KES Co., Ltd.  
The test results in the report only apply to the tested sample.

## 6. Test Setup Photographs

### 6.1 Conducted Emission

#### - AC Main

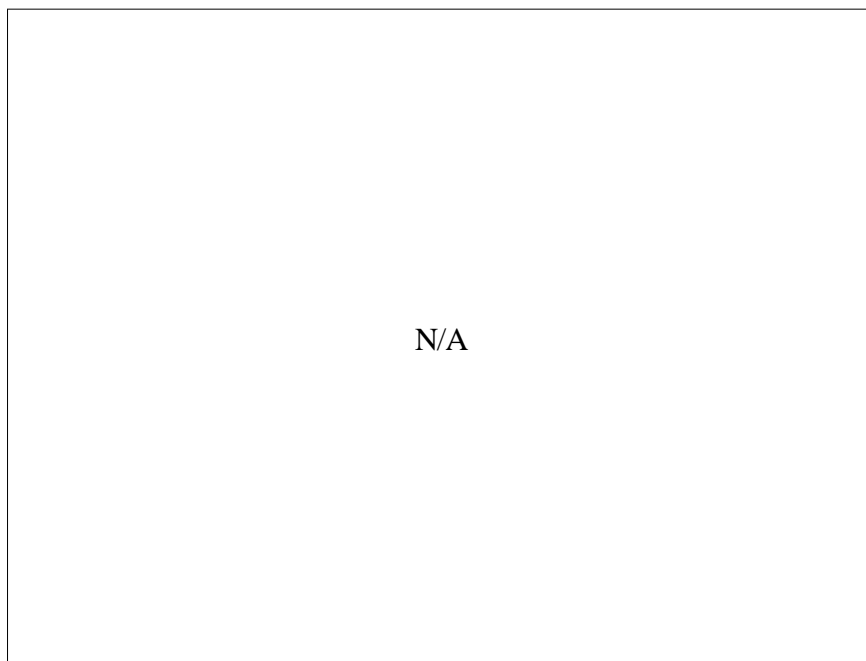
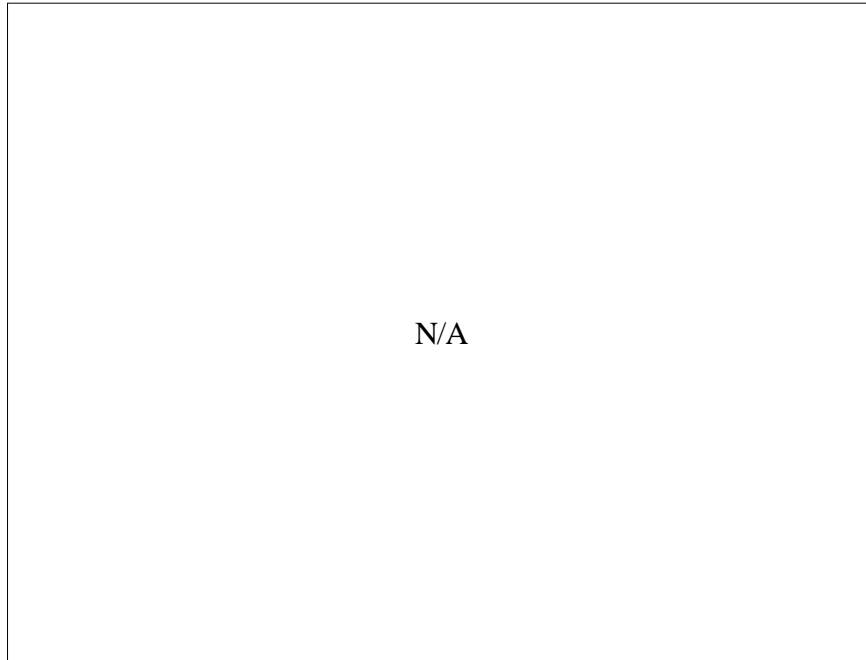



- **Telecommunication Emission**

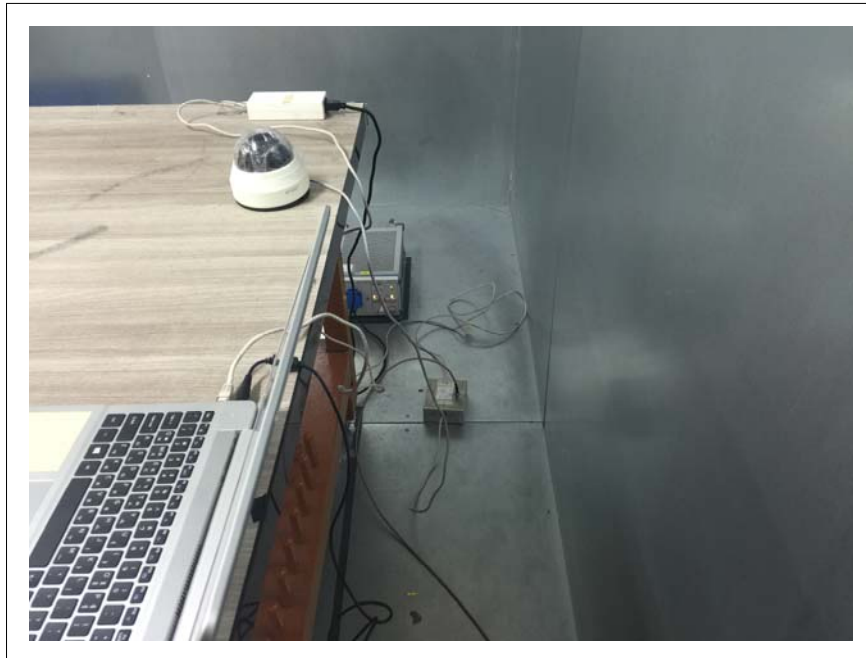
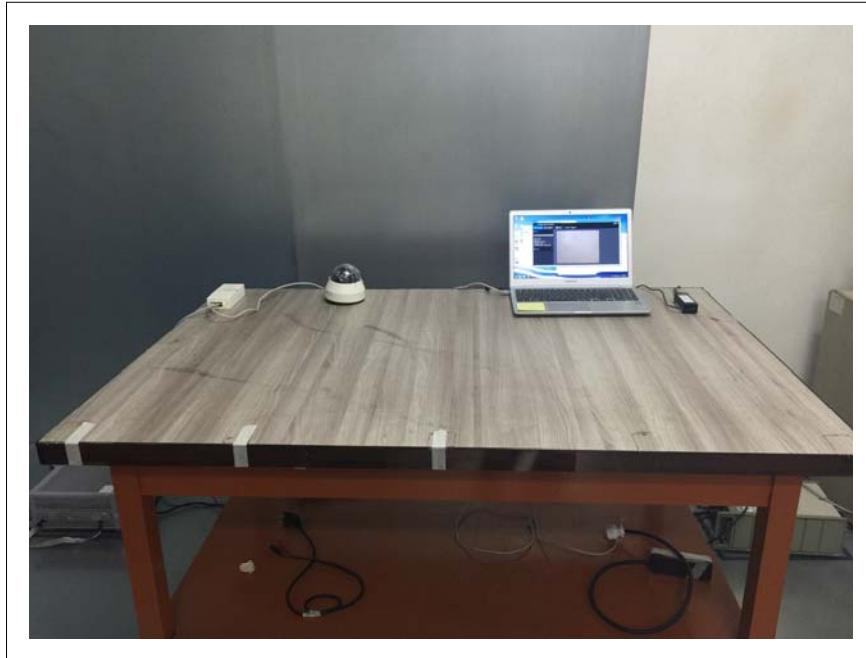

This report shall not be reproduced except in full, without the written approval of KES Co., Ltd.  
The test results in the report only apply to the tested sample.

## 6.2 Radiated Emission

\* Below 1 GHz



This report shall not be reproduced except in full, without the written approval of KES Co., Ltd.  
The test results in the report only apply to the tested sample.

\* Above 1 GHz

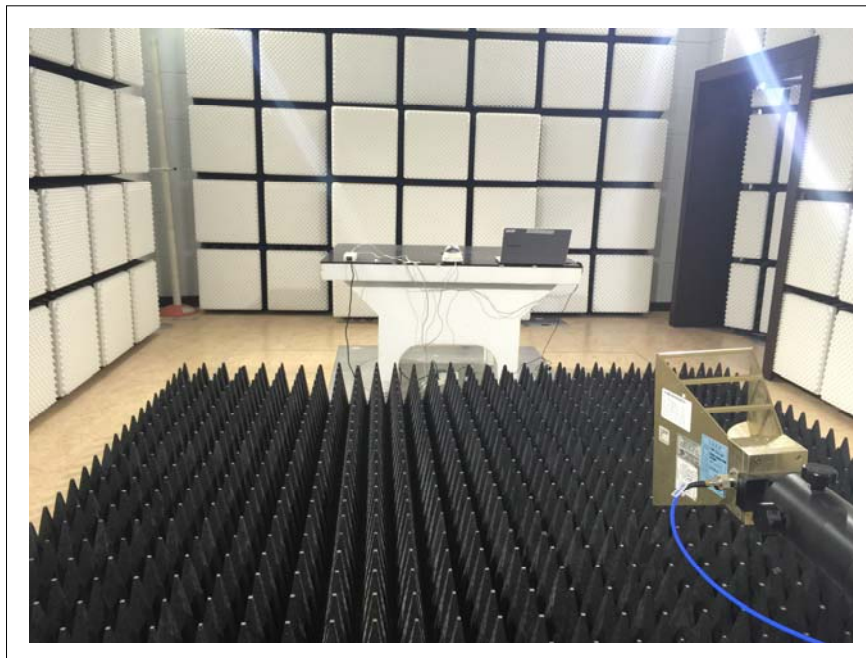

This report shall not be reproduced except in full, without the written approval of KES Co., Ltd.  
The test results in the report only apply to the tested sample.

### 6.3 Harmonics / Voltage Fluctuations

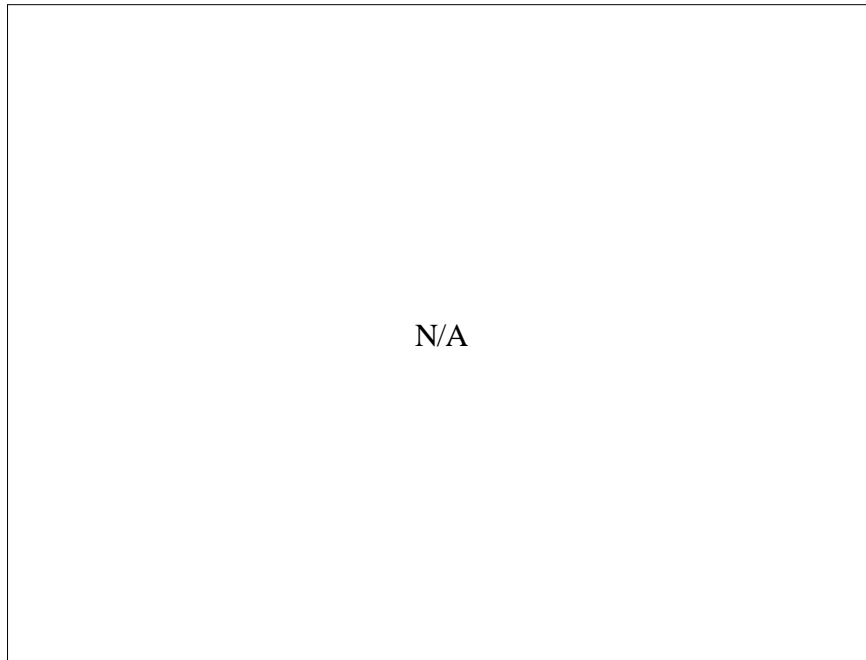

## 6.4 Electrostatic Discharge Immunity



## 6.5 Radio frequency electromagnetic field immunity

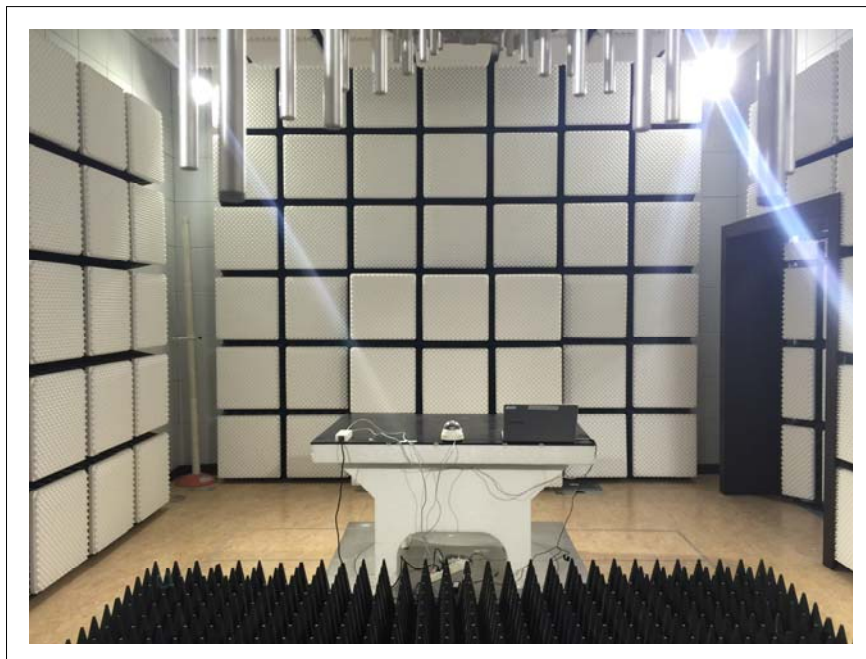

This report shall not be reproduced except in full, without the written approval of KES Co., Ltd.  
The test results in the report only apply to the tested sample.

## 6.6 Fast Transient Immunity

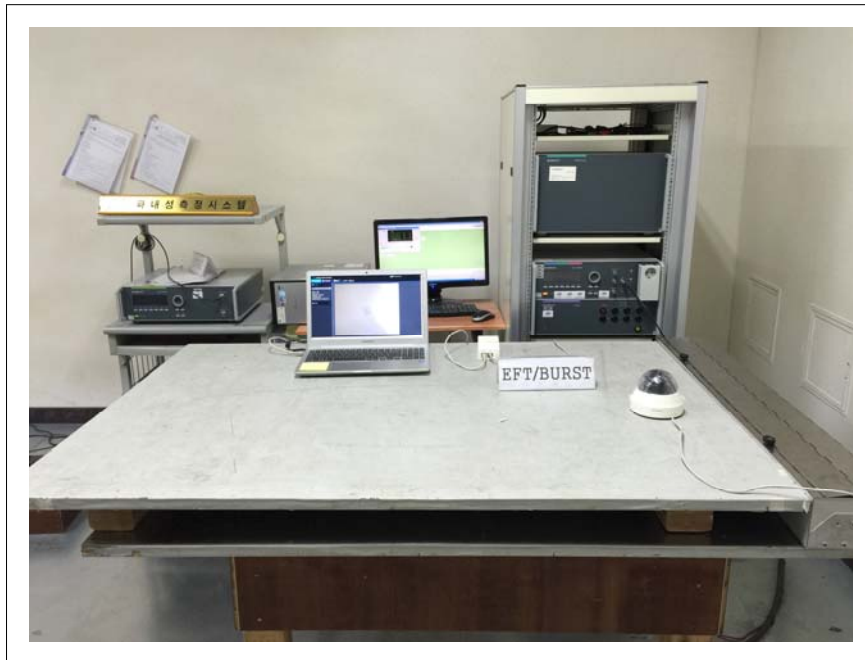

## 6.7 Surge Immunity

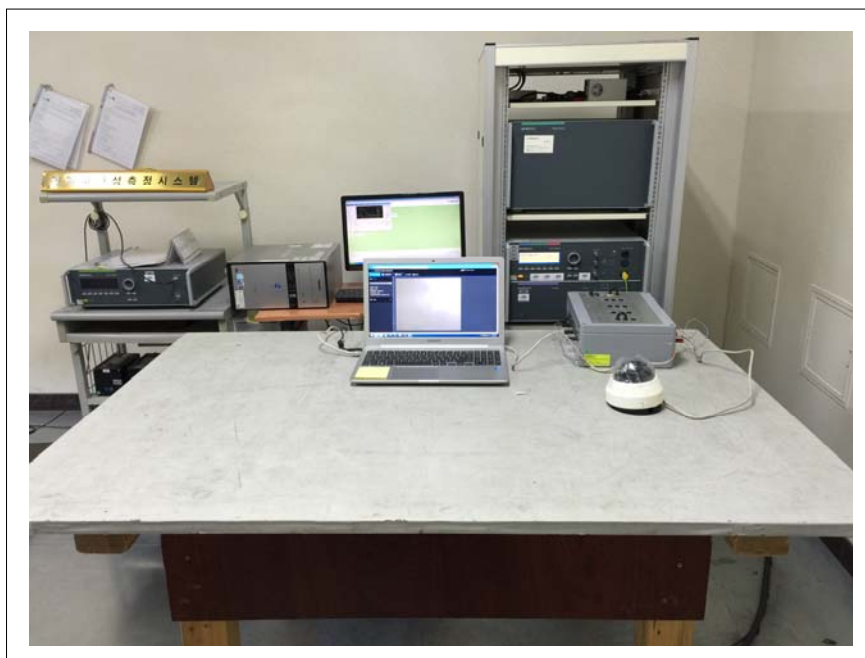

This report shall not be reproduced except in full, without the written approval of KES Co., Ltd.  
The test results in the report only apply to the tested sample.

## 6.8 Radio-frequency continuous conducted Immunity



## 6.9 Voltage Dips and Voltage Interruptions Immunity

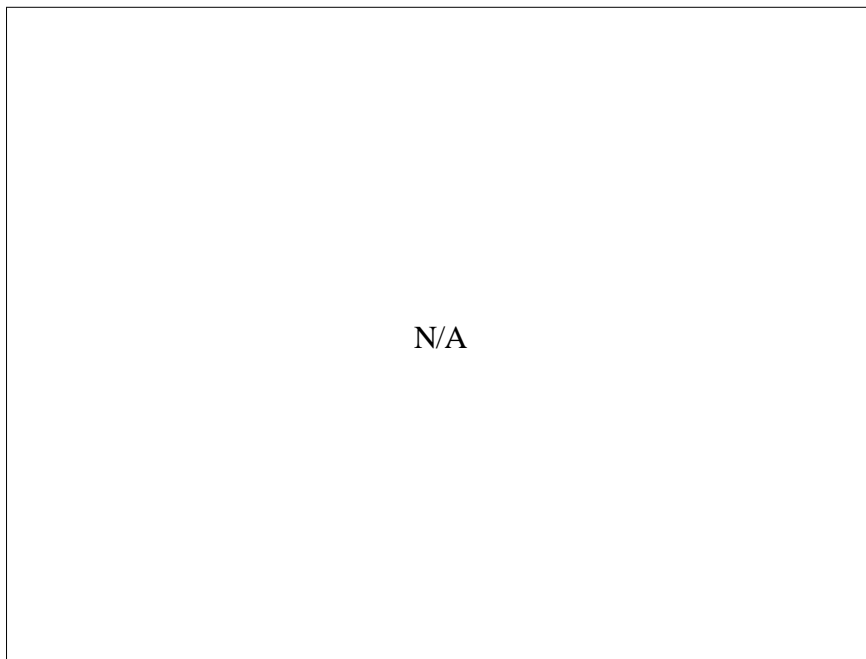

## 7. External Photographs



[ FRONT VIEW ]



[ REAR VIEW ]

This report shall not be reproduced except in full, without the written approval of KES Co., Ltd.  
The test results in the report only apply to the tested sample.



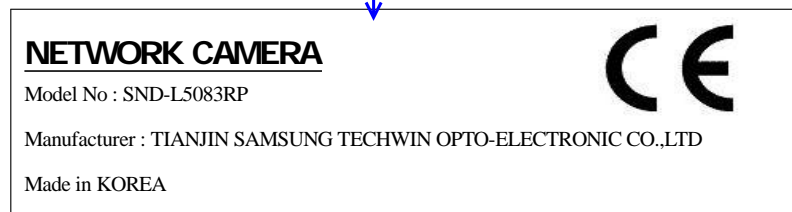

[LABEL VIEW]

## 8. Internal Photographs



[INTERNAL VIEW]

This report shall not be reproduced except in full, without the written approval of KES Co., Ltd.  
The test results in the report only apply to the tested sample.

○ Camera Unit Main Board



[TOP VIEW]

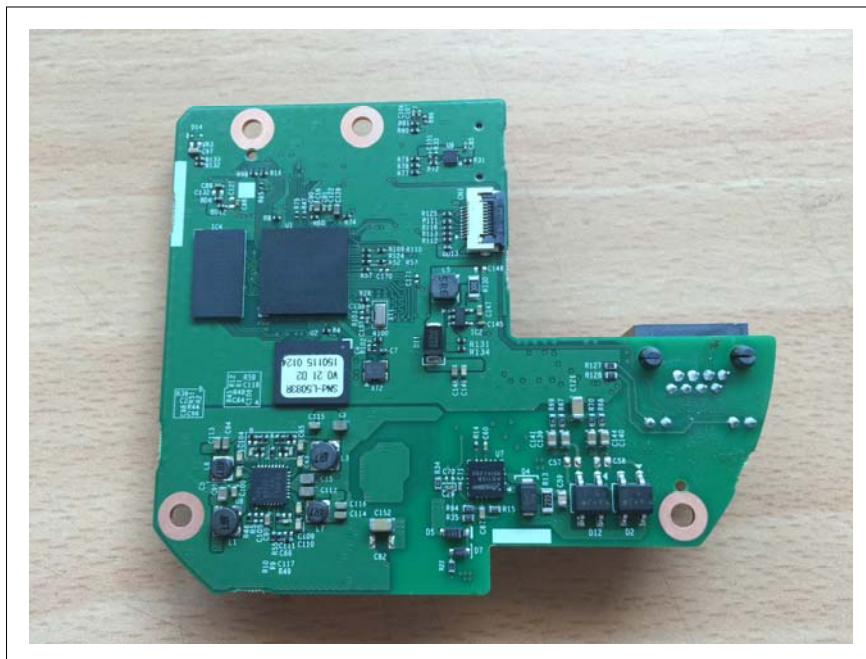

[BOTTOM VIEW]

This report shall not be reproduced except in full, without the written approval of KES Co., Ltd.  
The test results in the report only apply to the tested sample.

○ Lens Board



[TOP VIEW]



[BOTTOM VIEW]

This report shall not be reproduced except in full, without the written approval of KES Co., Ltd.  
The test results in the report only apply to the tested sample.

○ LED Board



[TOP VIEW]



[BOTTOM VIEW]

This report shall not be reproduced except in full, without the written approval of KES Co., Ltd.  
The test results in the report only apply to the tested sample.



## **Appendix A - Schematics/Block Diagram**

Please see attached document(s).



**KES Co., Ltd.**

C-3701, 40, Simin-daero 365beon-gil,  
Dongan-gu, Anyang-si, Gyeonggi-do, 431-716, Korea  
Tel: +82-31-425-6200 / Fax: +82-31-424-0450  
www.kes.co.kr

Test report No.:  
KES-E1-15T0077  
Page (62) of (61)

---

**Appendix B - User's Manual**

Please see attached document(s).

---

This report shall not be reproduced except in full, without the written approval of KES Co., Ltd.  
The test results in the report only apply to the tested sample.